



inori

DESIGN
SETSU & SHINOBU ITO

modello registrato
registered model

Basi _ Bases

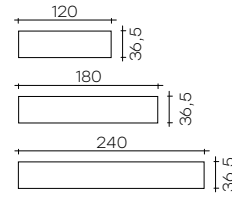

Ripiani _ Shelves

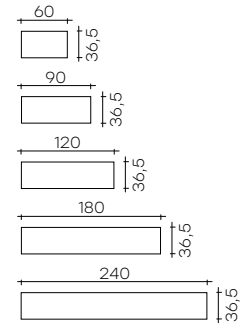

Montanti _ Uprights

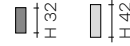

Sistema composto da elementi in vetro o legno modulari. La modularità e versatilità ne permette l'utilizzo come libreria, espositore, contenitore porta tv, sviluppabili sia in situazioni con fissaggio a muro che autoportanti. Tutti i montanti sono liberamente posizionabili tramite sistema di ancoraggio e scorrimento a binario applicato su ogni singolo ripiano. Binario in alluminio anodizzato nero.

Modular book shelves glass or wood system. The versatility and assembly possibilities allow the utilization as a show-case, display-case, TV-unit. Available the free-standing version and wall unit. The uprights are freely adjustable on each shelf through sliding rails and fixing device. Slides in anodized black aluminum.

portata sui ripiani: 80 kg
portata massima struttura: 400 kg
distanza massima tra i montanti: 130 cm
massimo sbalzo laterale sui ripiani: 35 cm
load capacity on shelves: 80 kg
structure load capacity: 400 kg
max. distance between the uprights: 130 cm
max. distance between the external side of the shelves: 35 cm

COMPOSIZIONI / COMPOSITIONS

COMP. A COMP. A

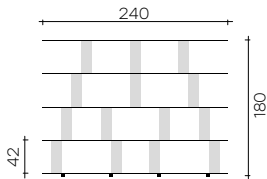

COMP. A bis COMP. A bis

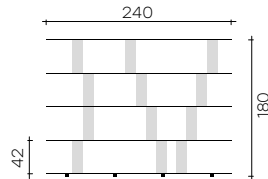

COMP. B COMP. B

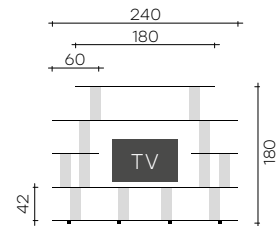

COMP. C COMP. C

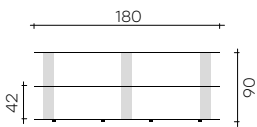

COMP. D COMP. D

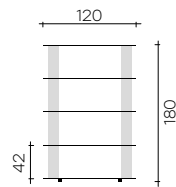

COMP. E COMP. E

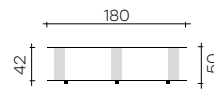

COMP. F COMP. F

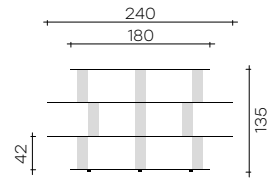

In tutte le composizioni sopra presentate i montanti hanno altezza H. 42 cm.

In all the compositions presented above, the uprights are 42 cm high.



dimensioni L, P, H dimensions L, W, H (cm)	COD./CODE	L	P/W	H	peso netto net weight (kg)	peso lordo gross weight (kg)	volume imballo package volume (m³)
COMPOSIZIONE A COMPOSITION A							
base: fumé retro verniciata nera 4 ripiani: fumé 14 montanti: extralight <i>base: smoked glass black back-painted</i> <i>4 shelves: smoked glass</i> <i>14 uprights: extralight</i>	8401	240	36,5	180	195	218	0,42
COMPOSIZIONE A bis COMPOSITION A bis							
base: fumé retro verniciata nera 4 ripiani: trasparenti 12 montanti: trasparenti <i>base: smoked glass black back-painted</i> <i>4 shelves: transparent</i> <i>12 uprights: transparent</i>	8401/bis	240	36,5	180	186	214	0,36
COMPOSIZIONE B COMPOSITION B							
base: extralight retro verniciata bianca 5 ripiani: trasparenti 12 montanti: trasparenti <i>base: extralight white back-painted</i> <i>5 shelves: transparent</i> <i>12 uprights: transparent</i>	8402	240	36,5	180	168	180	0,34
COMPOSIZIONE C COMPOSITION C							
base: fumé retro verniciata nera 2 ripiani: fumé 6 montanti: nero95 <i>base: smoked glass black back-painted</i> <i>2 shelves: smoked glass</i> <i>6 uprights: black95</i>	8403	180	36,5	90	89	100	0,18
COMPOSIZIONE D COMPOSITION D							
base: extralight retroverniciata bianca 4 ripiani: trasparenti 8 montanti: trasparenti <i>base: extralight white back-painted</i> <i>4 shelves: transparent</i> <i>8 uprights: transparent</i>	8404	120	36,5	180	108	126	0,25
COMPOSIZIONE E COMPOSITION E							
base: fumé retro verniciata nera 1 ripiani: extralight 3 montanti: nero95 <i>base: smoked glass black back-painted</i> <i>1 shelves: extralight</i> <i>3 uprights: black95</i>	8405	180	36,5	50	55	62	0,12
COMPOSIZIONE F COMPOSITION F							
base: fumé retro verniciata nera 3 ripiani: fumé 9 montanti: trasparenti <i>base: smoked glass black back-painted</i> <i>3 shelves: smoked glass</i> <i>9 uprights: transparent</i>	8406	240	36,5	135	132	149	0,26

Le composizioni sono intese ad agevolare la vendita proponendo una soluzione ed un prezzo predefiniti. Per altre e diverse composizioni e finiture riferirsi esclusivamente al listino dei singoli componenti.

All configurations are meant to help and promote sales by proposing a set solution and price. For all other possible configurations and finishings please refer to listed single components.



inori
 DESIGN
 SETSU & SHINOBU ITO
 modello registrato
 registered model

portata sui ripiani: 80 kg
 portata massima struttura: 400 kg
 distanza massima tra i montanti: 130 cm
 massimo sbalzo laterale sui ripiani: 35 cm
 load capacity on shelves: 80 kg
 structure load capacity: 400 kg
 max. distance between the uprights: 130 cm
 max. distance between the external side
 of the shelves: 35 cm

Basi _ Bases

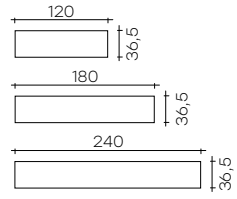

Ripiani _ Shelves

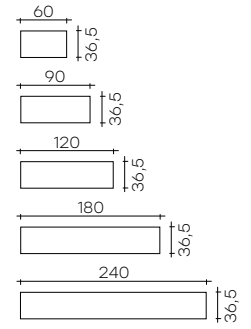

Montanti _ Uprights

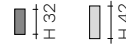

ALCUNI SUGGERIMENTI TRA LE INFINITE SOLUZIONI / JUST A FEW OF THE NUMEROUS SOLUTIONS
RIPIANI IN VETRO, SPESSORE 12 MM / GLASS SHELVES, 12 MM-THICK

**LIBRERIA
BOOKCASE**

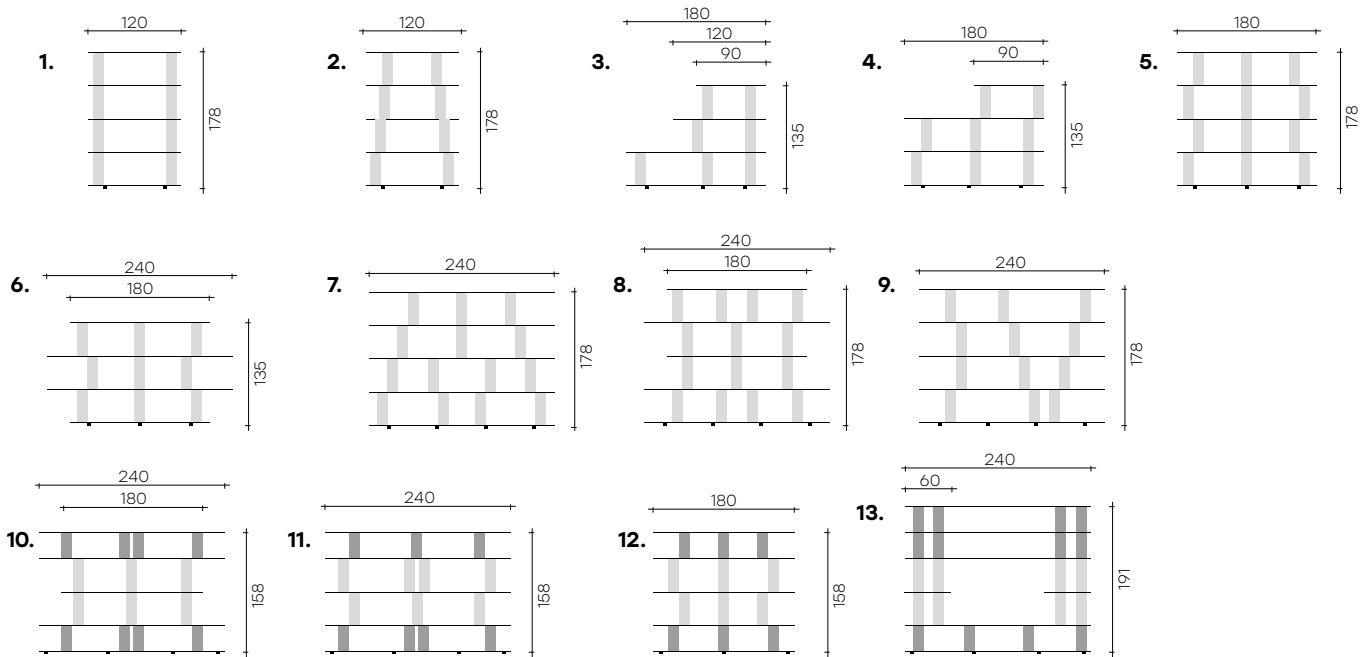

**PORTA TV
TV UNIT**

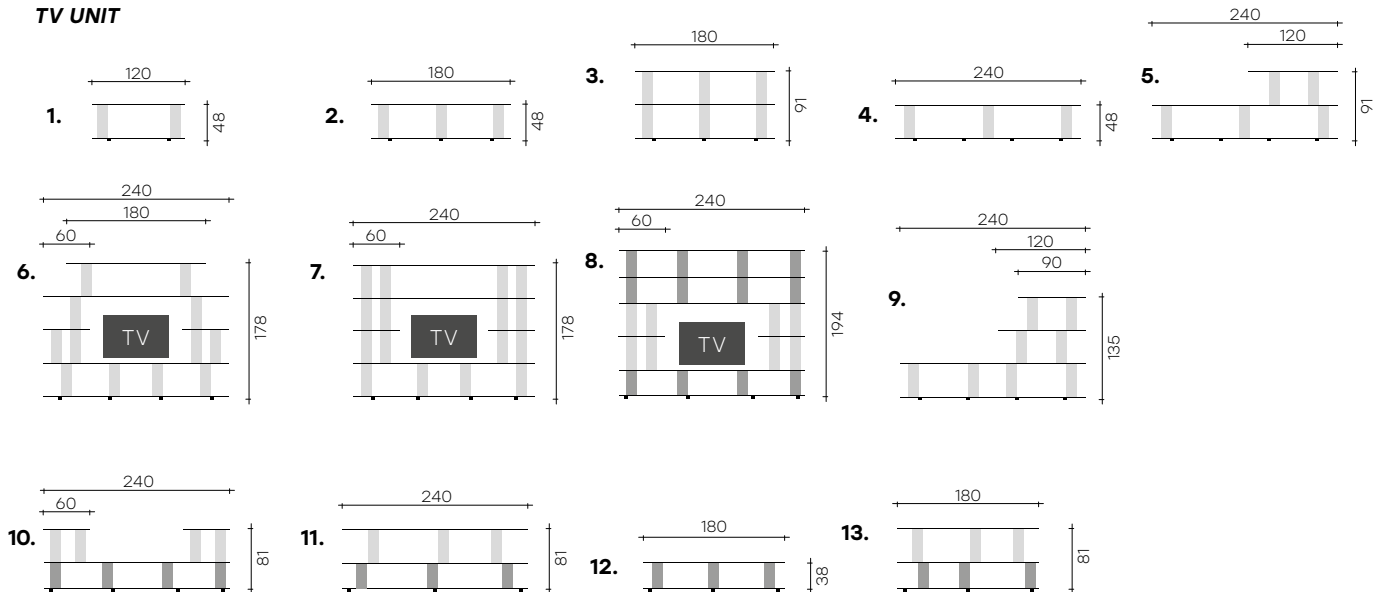



CONSOLLE CONSOLE

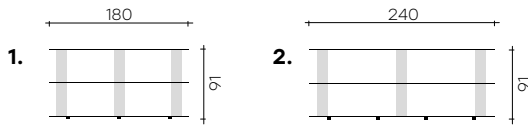

RETRO DIVANO SOFA BACK SIDEBORD

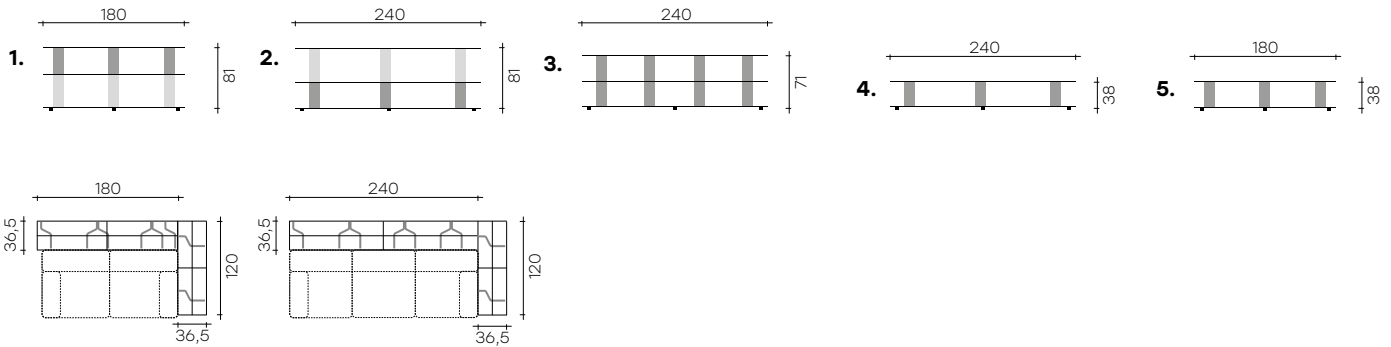

MOBILE BASSO LOW UNIT

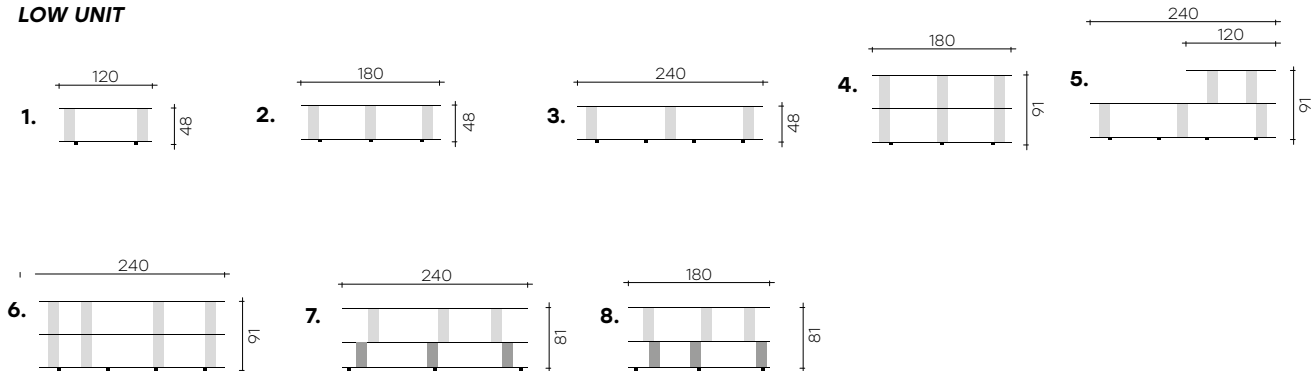

SOLUZIONE CENTROSTANZA ROOM CENTREPIECE SOLUTION

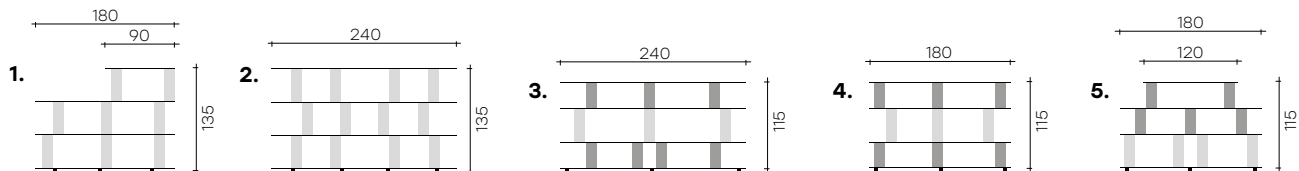

Altezza massima per le strutture autoportanti
 Su basi di lunghezza 120 cm: h max 48 cm (vetro) o 51 cm (legno)
 Su basi di lunghezza 180 cm: h max 135 cm (vetro) o 143 cm (legno)
 Su basi di lunghezza 240 cm: h max 178 cm (vetro) o 189 cm (legno)
 con accessorio dedicato
 Altezza massima per le strutture con ancoraggio a muro:
 massimo 5 ripiani in vetro, 6 ripiani in legno, base esclusa.

Max. height of the free-standing version
With base length 120 cm: h max 48 cm (glass) or 51 cm (wood)
With base length 180 cm: h max 135 cm (glass) or 143 cm (wood)
With base length 240 cm: h max 178 (glass) or 189 cm (wood)
with accessories
Max. height of the wall version:
max 5 glass shelves, max 6 wood shelves, base excluded.



inori

DESIGN
SETSU & SHINOBU ITO

modello registrato
registered model

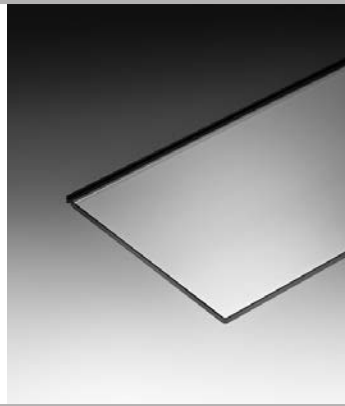

Ripiani in vetro temperato,
spessore 12 mm
o legno spessore 40 mm.
*Shelves in tempered glass,
12 mm-thick
or wood 40 mm-thick.*

Base d'appoggio in vetro
temperato, spessore 12 mm
o legno spessore 40 mm.
*Base in tempered glass,
12 mm-thick
or wood 40 mm-thick.*

Montanti in vetro curvato
da 10 mm.
*Uprights in curved glass,
10 mm-thick.*

portata sui ripiani: 80 kg
portata massima
struttura: 400 kg
distanza massima
tra i montanti: 130 cm
massimo sbalzo laterale
sui ripiani: 35 cm
*load capacity on shelves: 80 kg
structure load capacity: 400 kg
max. distance between
the uprights: 130 cm
max. distance between the
external uprights and the lateral
side of the shelves: 35 cm*

Altezza massima
per le strutture autoportanti
su basi di lunghezza 120 cm:
h max 48 cm (vetro)
o 51 cm (legno).
Su basi di lunghezza 180 cm:
h max 135 cm (vetro)
o 143 cm (legno).
Su basi di lunghezza 240 cm:
h 178 cm (vetro) o 189 cm (legno)
con accessorio dedicato.
Altezza massima per le strutture
con ancoraggio a muro:
massimo 5 ripiani in vetro,
6 ripiani in legno,
base esclusa.

*Max. height
of the free-standing version
With base length 120 cm:
h max 48 cm (glass)
or 51 cm (wood)
With base length 180 cm:
h max 135 cm (glass)
or 143 cm (wood)
With base length 240 cm:
h max 178 (glass)
or 189 cm (wood)
with accessories
Max. height of the wall
version: max 5 glass shelves,
max 6 wood shelves,
base excluded.*

dimensioni L, P, H dimensions L, W, H (cm)	COD./CODE	L	P/W	H	peso netto net weight (kg)	peso lordo gross weight (kg)	volume imballo package volume (m ³)
BASI BASES							
Fumé retro verniciato nero. <i>Smoked glass black back-painted.</i>	12036/N	120	36,5	5	16	18	0,04
	18036/N	180	36,5	5	22	24	0,06
	24036/N	240	36,5	5	28	30	0,08
Extralight retro verniciato bianco. <i>Extralight white back-painted.</i>	12036/B	120	36,5	5	16	18	0,04
	18036/B	180	36,5	5	22	24	0,06
	24036/B	240	36,5	5	28	30	0,08
Rovere "Old". <i>"Old Style" oak.</i>	18036/RO	180	37,5	5	16	18	0,06
	24036/RO	240	37,5	5	21	23	0,09
Noce Canaletto, tinto Tabacco. <i>Canaletto walnut, Tobacco finish.</i>	18036/NTA	180	37,5	5	16	18	0,06
	24036/NTA	240	37,5	5	21	23	0,09
Noce termotrattato nero. <i>Heath-treated black finish walnut.</i>	18036/TNE	180	37,5	5	16	18	0,06
	24036/TNE	240	37,5	5	21	23	0,09



dimensioni L, P, H dimensions L, W, H (cm)	COD./CODE	L	P/W	H	peso netto net weight (kg)	peso lordo gross weight (kg)	volume imballo package volume (m³)
RIPIANI / SHELVES							
Trasparente. Transparent.	6036	60	36,5	1,2	7	8	0,01
	9036	90	36,5	1,2	10	11	0,01
	1236	120	36,5	1,2	14	16	0,02
	1836	180	36,5	1,2	20	22	0,03
	2436	240	36,5	1,2	26	28	0,04
Fumé. Smoked glass.	6036/F	60	36,5	1,2	7	8	0,01
	9036/F	90	36,5	1,2	10	11	0,01
	1236/F	120	36,5	1,2	14	16	0,02
	1836/F	180	36,5	1,2	20	22	0,03
	2436/F	240	36,5	1,2	26	28	0,04
Extralight. Extralight.	6036/X	60	36,5	1,2	7	8	0,01
	9036/X	90	36,5	1,2	10	11	0,01
	1236/X	120	36,5	1,2	14	16	0,02
	1836/X	180	36,5	1,2	20	22	0,03
	2436/X	240	36,5	1,2	26	28	0,04
Rovere "Old". "Old Style" oak.	1836/RO	180	37,5	4	16	18	0,06
	2436/RO	240	37,5	4	21	23	0,08
Noce canaletto tinto Tabacco. Canaletto walnut, Tobacco finish.	1836/NTA	180	37,5	4	16	18	0,06
	2436/NTA	240	37,5	4	21	23	0,08
Noce termotrattato nero. Heath-treated black finish walnut.	1836/TNE	180	37,5	4	16	18	0,06
	2436/TNE	240	37,5	4	21	23	0,08
PIANO SUPERIORE (senza fresata) / TOP (without groove)							
Rovere "Old". "Old Style" oak.	1836/TRO	180	37,5	4	16	18	0,06
	2436/TRO	240	37,5	4	21	23	0,08
Noce canaletto tinto Tabacco. Canaletto walnut, Tobacco finish.	1836/T-NTA	180	37,5	4	16	18	0,06
	2436/T-NTA	240	37,5	4	21	23	0,08
Noce termotrattato nero. Heath-treated black finish walnut.	1836/T-TNE	180	37,5	4	16	18	0,06
	2436/T-TNE	240	37,5	4	21	23	0,08

Per finiture su richiesta di basi e ripiani in legno contattare il custom service.

Customized finishes of wooden base and shelves are available on demand. Please contact customer service

**FINITURA BASE E RIPIANI IN VETRO RETROLACCATO
BACK-LACQUERED GLASS BASE AND SHELVES FINISH**

**SPESSORE
THICKNESS**

Vetro extralight retrolaccato
Extralight back-lacquered glass

12 mm



dimensioni L, P, H dimensions L, W, H (cm)	COD./CODE	L	P/W	H	peso netto net weight (kg)	peso lordo gross weight (kg)	volume imballo package volume (m ³)
MONTANTI UPRIGHTS							
Trasparente. Transparent.	3532		35	32	4,5	6	0,03
	3542		35	42	4,5	6	0,03
Nero95. Black95.	3532/ N95		35	32	4,5	6	0,03
	3542/ N95		35	42	4,5	6	0,03
Extralight. Extralight.	3532/X		35	32	4,5	6	0,03
	3542/X		35	42	4,5	6	0,03
Bronzo. Bronze.	3532/BR		35	32	4,5	6	0,03
	3542/BR		35	42	4,5	6	0,03
Fumè. Smoked.	3532/FU		35	32	4,5	6	0,03
	3542/FU		35	42	4,5	6	0,03

Accessori/Accessories

dimensioni L, P, H dimensions L, W, H (cm)	COD./CODE	L	P/W	H	peso netto net weight (kg)	peso lordo gross weight (kg)	volume imballo package volume (m ³)
Barre di irrigidimento in alluminio anodizzato nero per le versioni autoportanti nella misura larga cm 240, da altezza minima 135 cm sino all'altezza massima 180 cm. <i>Black anodised aluminium reinforcement bars The system can also be used to construct free-standing compositions: in width 240 cm, from a height of minimum 135 cm up to the maximum height of 180 cm the system is complete with black anodised aluminium reinforcement bars.</i>	ACC/N versione vetro glass version				2	3	0,01
	ACC/NL versione legno wood version				2	3	0,01

Altezza massima per le strutture autoportanti
Su basi di lunghezza 120 cm: h max 48 cm (vetro) o 51 cm (legno)
Su basi di lunghezza 180 cm: h max 135 cm (vetro) o 143 cm (legno)
Su basi di lunghezza 240 cm: h 178 cm (vetro) o 189 cm (legno)
con accessorio dedicato
Altezza massima per le strutture con ancoraggio a muro:
massimo 5 ripiani in vetro, 6 ripiani in legno, base esclusa.

*Max. height of the free-standing version
With base length 120 cm: h max 48 cm (glass) or 51 cm (wood)
With base length 180 cm: h max 135 cm (glass) or 143 cm (wood)
With base length 240 cm: h max 178 (glass) or 189 cm (wood)
with accessories
Max. height of the wall version:
max 5 glass shelves, max 6 wood shelves, base excluded.*



FAC-SIMILE MODULO ORDINE _ ORDER FORM

RIPIANI SHELVES	60 cm			90 cm			120 cm		
	6036	6036/F	6036/X	9036	9036/F	9036/X	1236	1236/F	1236/X
	Transparente <i>Transparent</i>	Fumè <i>Smoked</i>	Xlight	Transparente <i>Transparent</i>	Fumè <i>Smoked</i>	Xlight	Transparente <i>Transparent</i>	Fumè <i>Smoked</i>	Xlight
Quantità / Qty									

RIPIANI SHELVES	180 cm						240 cm					
	1836	1836/F	1836/X	1836/RO	1836/NTA	1836/TNE	2436	2436/F	2436/X	2436/RO	2436/NTA	2436/TNE
	Transp. <i>Transparent</i>	Fumè <i>Smoked</i>	Xlight	Rovere Old <i>Old Style oak</i>	Noce can. tinto tabacco <i>Canaletto walnut - Tobacco</i>	Noce termot. nero <i>Heat-treated black finish walnut</i>		Transp. <i>Transparent</i>	Fumè <i>Smoked</i>	Xlight	Rovere Old <i>Old Style oak</i>	Noce can. tinto tabacco <i>Canaletto walnut - Tobacco</i>
Quantità / Qty												

BASI BASES	120 cm			180 cm			
	12036/N	12036/B	18036/N	18036/B	18036/RO	18036/NTA	18036/TNE
	Nero (F) <i>Black (F)</i>	Bianco (X) <i>White (X)</i>	Nero (F) <i>Black (F)</i>	Bianco (X) <i>White (X)</i>	Rovere Old <i>Old Style oak</i>	Noce can. tinto tabacco <i>Canaletto walnut - Tobacco</i>	Noce termot. nero <i>Heat-treated black finish walnut</i>
Quantità / Qty							

BASI BASES	240 cm				
	24036/N	24036/B	24036/RO	24036/NTA	24036/TNE
	Nero (F) <i>Black (F)</i>	Bianco (X) <i>White (X)</i>	Rovere Old <i>Old Style oak</i>	Noce can. tinto tabacco <i>Canaletto walnut - Tobacco</i>	Noce termot. nero <i>Heat-treated black finish walnut</i>
Quantità / Qty					

* MONTANTI UPRIGHTS	32 cm					42 cm				
	3532	3532/N95	3532/X	3532/BR	3532/FU	3542	3542/N95	3542/X	3542/BR	3542/FU
	Transparente <i>Transparent</i>	Nero95 <i>Black95</i>	Xlight	Bronzo <i>Bronze</i>	Fumè <i>Smoked</i>	Transparente <i>Transparent</i>	Nero95 <i>Black95</i>	Xlight	Bronzo <i>Bronze</i>	Fumè <i>Smoked</i>
Quantità / Qty										

Esempio _ Example

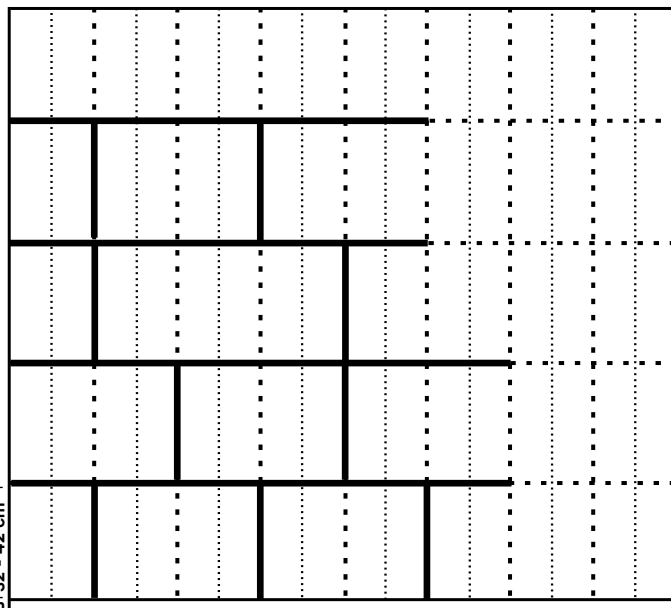

L. max 240 cm

30 cm

La tua Inori _ Your Inori

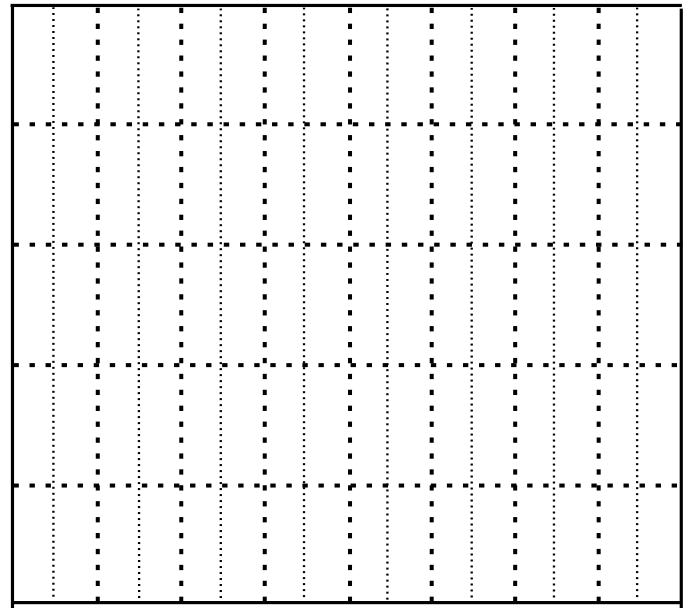

L. 240 cm



FINITURE FINISHES

Base in legno Wood base



rovere "Old"
"Old Style" oak



noce canaletto
finitura tabacco
canaletto walnut
tobacco finish



noce termotrattato nero
heath-treated black
finish walnut

Base in vetro Glass base



vetro extralight
retroverniciato bianco
extralight white
back-painted glass



vetro fumé
retroverniciato nero
smoked glass
black back-stained



**FINITURE
FINISHES**

**Ripiano in legno
Wood shelf**

rovere "Old"
"Old Style" oak



noce canaletto
finitura tabacco
canaletto walnut
tobacco finish



noce termotrattato nero
heat-treated black
finish walnut

**Ripiano in vetro
Glass shelf**

vetro trasparente
transparent glass



vetro extralight
extralight glass



vetro fumé
smoked glass



FINITURE
FINISHES

Montante in vetro curvato
Curved glass upright



vetro trasparente
transparent glass



vetro extralight
extralight glass



nero95
black95



vetro bronzo
bronze glass

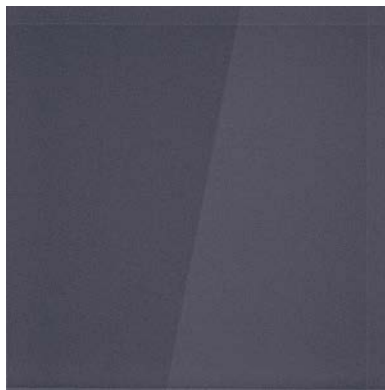

vetro fumé
smoked glass