



Table with a solid wood top with glued slats, characterized by a thin thickness thanks to the bevelled and rounded edges, which give it a light and sinuous design, and paired with winding iron legs evoking the flexibility of a ribbon.

CODE	SIZE	BASE	A1	A2	A4
NASTRO 1	W.200 x D.100 x H.76	B2	■	■	■
		B3	■	■	■
		B4	■	■	■
		B5	■	■	■
NASTRO 2	W.220 x D.100 x H.76	B2	■	■	■
		B3	■	■	■
		B4	■	■	■
		B5	■	■	■
NASTRO 3	W.240 x D.100 x H.76	B2	■	■	■
		B3	■	■	■
		B4	■	■	■
		B5	■	■	■
NASTRO 4	W.260 x D.100 x H.76	B2	■	■	■
		B3	■	■	■
		B4	■	■	■
		B5	■	■	■
NASTRO 5	W.280 x D.100 x H.76	B2	■	■	■
		B3	■	■	■
		B4	■	■	■
		B5	■	■	■
NASTRO 6	W.300 x D.100 x H.76	B2	■	■	■
		B3	■	■	■
		B4	■	■	■
		B5	■	■	■







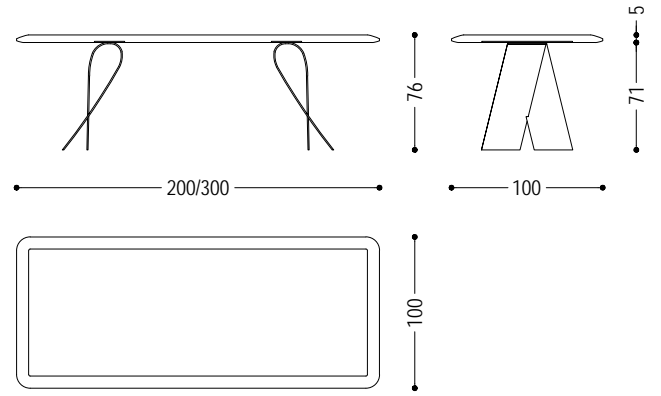

AVAILABLE FINISHES

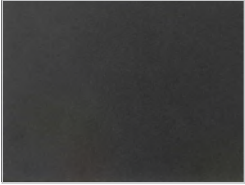
- A1:** walnut without knots, walnut with knots
- A2:** oak without knots, oak with knots, cherry
- A4:** oak without knots pigmented: white milk, total black
oak with knots pigmented: white milk, total black
- B2:** lacquered iron: iron dust, RAL (only selected colours)
- B3:** lacquered iron matt brushed effect: aged bronze, stainless steel, titanium
- B4:** lacquered iron: special RAL
- B5:** lacquered iron: bronze, cloudy effect

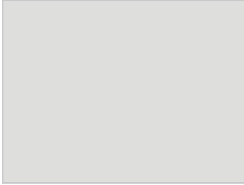

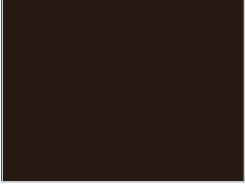
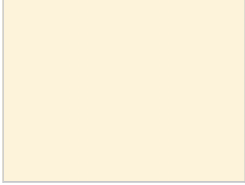
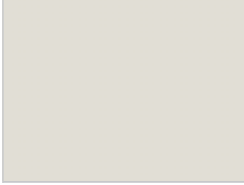

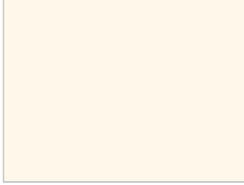
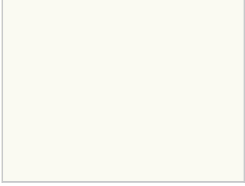
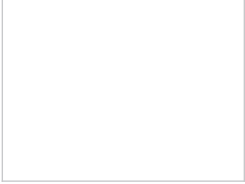
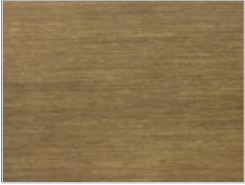



NASTRO

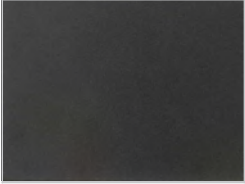

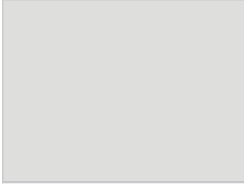

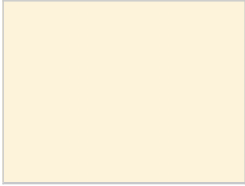
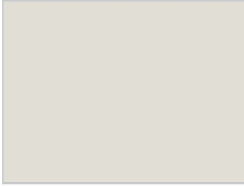

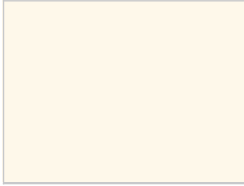
IRON

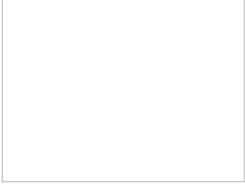
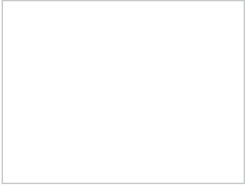
B2					
	lacquered iron: iron dust	ferro laccato: RAL - 1013_OYSTER WHITE	ferro laccato: RAL - 3020_TRAFFIC RED	ferro laccato: RAL - 7035_LIGHT GREY	ferro laccato: RAL - 7037_DUSTY GREY
					
	ferro laccato: RAL - 8019_GREY BROWN	ferro laccato: RAL - 9001_CREAM WHITE	ferro laccato: RAL - 9002_GREY WHITE	ferro laccato: RAL - 9005_JET BLACK	ferro laccato: RAL - 9010_PURE WHITE
					
	ferro laccato: RAL - 9016_TRAFFIC WHITE				
					
	lacquered iron: special RAL				
B3					
	lacquered iron, matt brushed effect: aged bronze	lacquered iron, matt brushed effect: stainless steel	lacquered iron, matt brushed effect: titanium		

NASTRO | AVAILABLE FINISHES

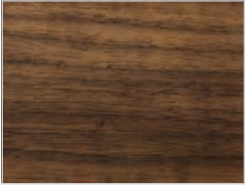
B2					
	lacquered iron: iron dust	ferro laccato: RAL - 1013_OYSTER WHITE	ferro laccato: RAL - 3020_TRAFFIC RED	ferro laccato: RAL - 7035_LIGHT GREY	ferro laccato: RAL - 7037_DUSTY GREY
					
	ferro laccato: RAL - 8019_GREY BROWN	ferro laccato: RAL - 9001_CREAM WHITE	ferro laccato: RAL - 9002_GREY WHITE	ferro laccato: RAL - 9005_JET BLACK	ferro laccato: RAL - 9010_PURE WHITE
					
	ferro laccato: RAL - 9016_TRAFFIC WHITE				
					
	lacquered iron: special RAL				
B5					
	lacquered iron: bronze, cloudy effect				

WOOD

A1			
	walnut without knots	walnut with knots	
A2			
	oak without knots	oak with knots	cherry

NASTRO | AVAILABLE FINISHES

A4



oak without knots pigmented:
white milk

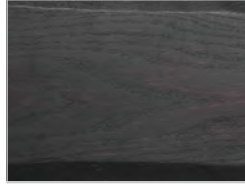

oak without knots pigmented:
total black

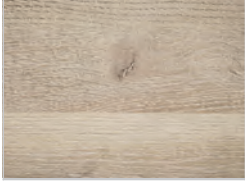

oak with knots pigmented:
white milk

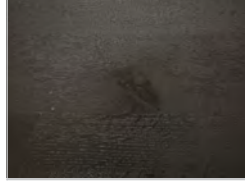

oak with knots pigmented:
total black