



The table features a top consisting of the combination of several curved staves interchanged with black resin inserts. The legs, each composed of two oval iron rings, echo the curved shape of the top slats.

CODE	SIZE	BASE	OAK STAVES
HYPNOTIC	W.240 x D.95/110 x H.75,5	B2	■
		B3	■

AVAILABLE FINISHES:





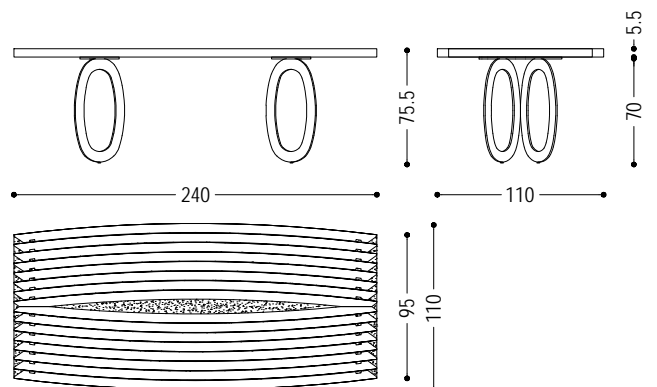

B2: lacquered iron: iron dust, RAL (only selected colours)

B3: lacquered iron matt brushed effect: aged bronze, stainless steel, titanium

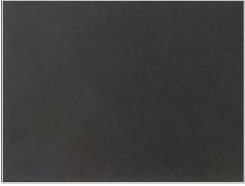
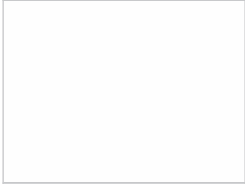

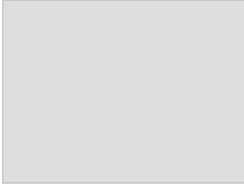
HYPNOTIC | AVAILABLE FINISHES

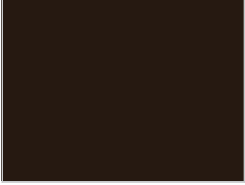
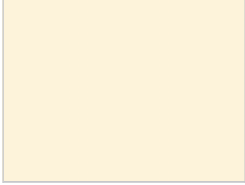
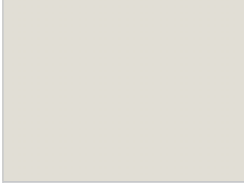
IRON

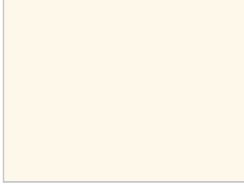
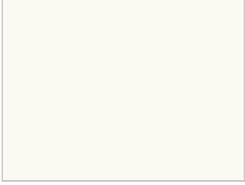
B2					
					
					
B3	