

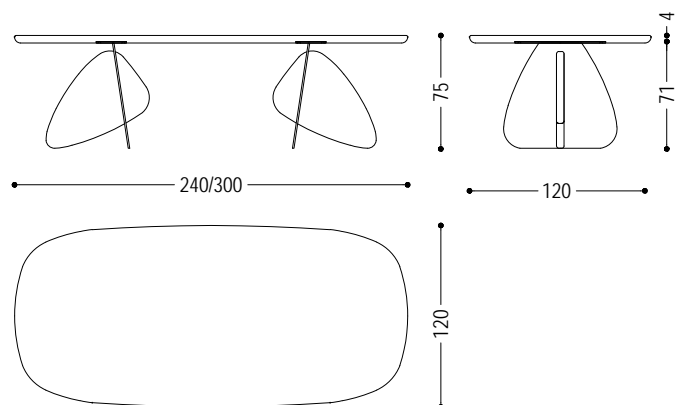

Table with a solid wood top with glued slats, with rounded corners, characterized by two legs, each composed of two volumes with soft contours, one in iron and the other in wood, meeting to create a game of intersections inspired by the shapes that can be found in untouched natural environments.

CODE	SIZE	BASE	A1	A2	A4
CROSS 1	W.240 x D.120 x H.75	B2	■	■	■
		B3	■	■	■
CROSS 2	W.260 x D.120 x H.75	B2	■	■	■
		B3	■	■	■
CROSS 3	W.280 x D.120 x H.75	B2	■	■	■
		B3	■	■	■
CROSS 4	W.300 x D.120 x H.75	B2	■	■	■
		B3	■	■	■



AVAILABLE FINISHES



- A1:** walnut without knots, walnut with knots
- A2:** oak without knots, oak with knots, cherry
- A4:** oak without knots pigmented: white milk, total black
oak with knots pigmented: white milk, total black
- B2:** lacquered iron: iron dust, RAL (only selected colours)
- B3:** lacquered iron matt brushed effect: aged bronze, stainless steel, titanium



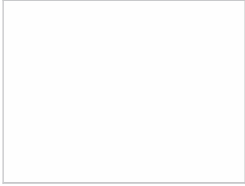

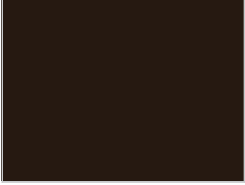
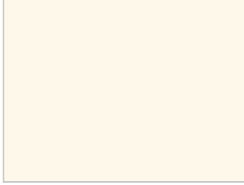

CROSS | AVAILABLE FINISHES

IRON

B2					
					
					

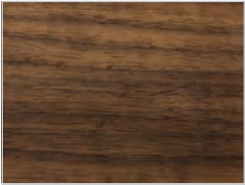
B3			
----	------------------------------------------------------------------------------------	------------------------------------------------------------------------------------	------------------------------------------------------------------------------------

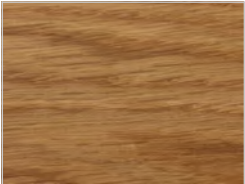
WOOD

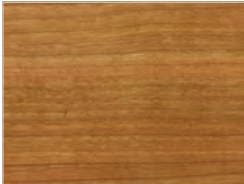
A1			
A2			

CROSS | AVAILABLE FINISHES

A4



oak without knots pigmented:
white milk

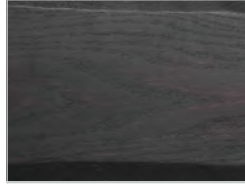

oak without knots pigmented:
total black

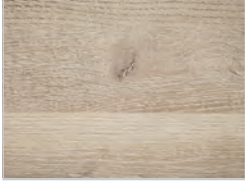

oak with knots pigmented:
white milk

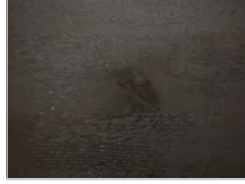

oak with knots pigmented:
total black