

# big wave

DESIGN LUDOVICA  
+ ROBERTO PALOMBA

modello registrato  
registered model

portata sul piano: 150 kg  
load capacity on top: 150 kg  
art. BW-300, BW-360: 200 kg

Tavolo con base composta da quattro o sei elementi in DV Glass da 30 mm a strisce colorate. Piano temperato in vetro da 15 mm trasparente retroverniciato con tinte monocromatiche, oppure ricoperto in Ecomalta, spatolatura tipo fine, oppure in legno impiallacciato noce canaletto finitura Tabacco spessore 40 mm.

Table with base made of four or six separate 30 mm DV Glass elements with colored stripes. Tempered top made of 15 mm transparent glass, back-lacquered with monochrome colors or hand-finished with Ecomalta, finergrained texture finish, or in Canaletto walnut veneered wood, Tobacco finish 40 mm thick.



SOLO VERSIONE CON TOP IN LEGNO  
ONLY WITH WOOD TOP

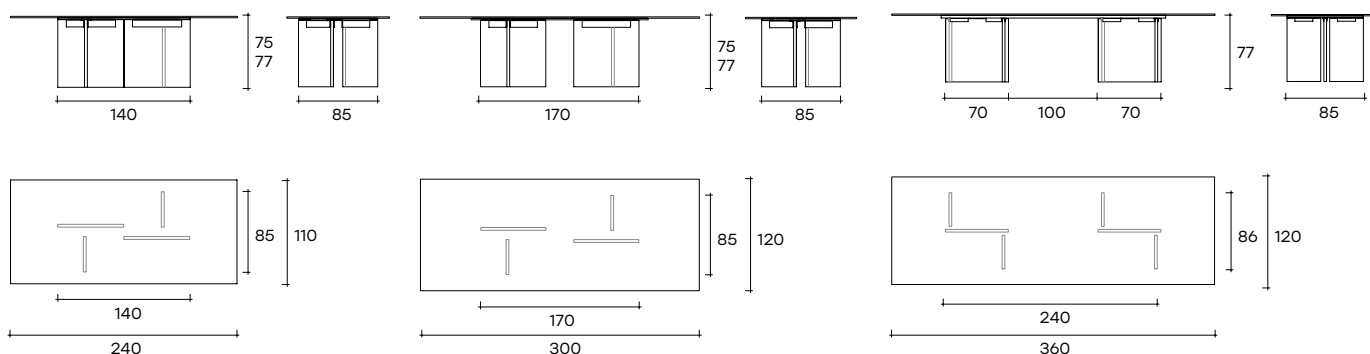

STRUTTURA DV-GLASS®  
DV-GLASS® STRUCTURE

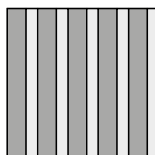
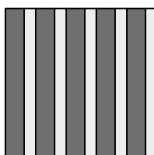
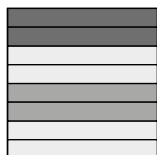

- Trasparente  
Transparent
- Fumè  
Smoke
- Bronzo  
Bronze

dimensioni L, P, H  
dimensions L, W, H  
(cm)

COD./CODE

L

P/W

H

peso netto  
net weight  
(kg)

peso lordo  
gross weight  
(kg)

volume imballo  
package volume  
(m<sup>3</sup>)

Tavolo con piano in vetro trasparente retroverniciato in tinta Cat.1. Base in DV Glass a strisce colorate.  
Table with top in transparent glass, back-lacquered - color Cat.1. Base made of colored DV glass.

**BW-CO240/V-**

240

110

75

237

316

0,9

**BW-CO300/V-**

300

120

75

278

373

1,05

Tavolo con piano in vetro ricoperto in Ecomalta finitura Nero Assoluto, Base in DV Glass a strisce verticali fumè e trasparenti.  
table with glass top hand-finished with ecomalta, Absolute Black finish. Base in DV-Glass made of smoked and transparent vertical stripes.

**BW-FU240/MNE**

240

110

75

237

316

0,9

**BW-FU300/MNE**

300

120

75

278

373

1,05

Tavolo con piano in vetro ricoperto in Ecomalta finitura Tabacco. Base in DV Glass a strisce verticali bronzo e trasparenti.

**BW-BR240/MTA**

240

110

75

237

316

0,9

**BW-BR300/MTA**

300

120

75

278

373

1,05

Table with glass top hand-finished with ecomalta, Tobacco finish. Base in DV-Glass made of bronze and transparent vertical stripes.

dimensioni L, P, H <i>dimensions L, W, H</i> (cm)	COD./CODE	L	P/W	H	peso netto <i>net weight</i> (kg)	peso lordo <i>gross weight</i> (kg)	volume imballo <i>package volume</i> (m <sup>3</sup> )
Tavolo con piano in legno impiallacciato noce canaletto finitura <i>Tabacco</i> . Base in DV Glass a strisce verticali bronzo e trasparenti. <i>Table with Canaletto walnut veneered wood, Tobacco finish. Base in DV-Glass made of bronze and transparent vertical stripes.</i>	<b>BW-BR240/NT</b>	240	110	77	213	250	0,64
	<b>BW-BR300/NT</b>	300	120	77	245	283	0,72
	<b>BW-BR360/NT</b>	360	120	77	313	363	0,92

#### VETRO RETROVERNICIATO \_ BACK PAINTED GLASS

CAT. COLORE <i>COLOR CAT.</i>	COLORI <i>COLORS</i>	CODICE _ CODE
		Vetro trasparente _ <i>Transparent glass</i>
<b>CAT.1</b> Tinta unita <i>Plain color</i>	Grigio grafite <i>Graphite grey</i>	V-GR
	Testa di moro <i>Dark brown</i>	V-MR
	Nero <i>Black</i>	V-N

#### DIMENSIONI CUSTOM *CUSTOM DIMENSIONS*

		DIMENSIONE PIANO _ <i>TOP DIMENSION</i>	
		min.	max.
<b>DIMENSIONE BASE <i>BASE DIMENSION</i></b>	<b>L 140 cm</b>	200x110 cm	240x110 cm
	<b>L 170 cm</b>	245x110 cm	300x120 cm
	<b>L 240 cm</b>	310x110 cm	360x120 cm

Massima dimensione realizzabile per top laccato 300x120.  
*Max feasible dimension for lacquered top 300x120.*

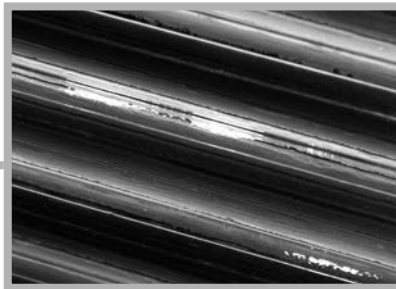

Lievi tracce, avvallamenti superficiali ed irregolarità interne ed esterne alla lastra in vetro sono segni distintivi del processo di fusione ad alta temperatura che ne garantiscono l'artigianalità. Non possono quindi essere oggetto di contestazione.  
*Slight traces on the surface, internal and external glass plate's irregularities are distinctive signs of the high-temperature fusion process that guarantee its craftsmanship. They cannot therefore be contested.*

# big wave

DESIGN LUDOVICA  
+ ROBERTO PALOMBA

modello registrato  
registered model

portata sul piano: 150 kg  
load capacity on top: 150 kg  
art. BW-300, BW-360: 200 kg

Tavolo tondo con base composta da tre o quattro elementi in DV Glass da 30 mm a strisce colorate. Piano in vetro temperato da 15 mm trasparente retroverniciato con tinte monocromatiche, oppure ricoperto in Ecomalta, spatolatura tipo fine.

Round table with base made of three or four separate 30 mm DV Glass elements with colored stripes. Top made of 15 mm transparent, tempered glass, back-lacquered with monochrome color or hand-finished with Ecomalta, finer-grained texture finish.

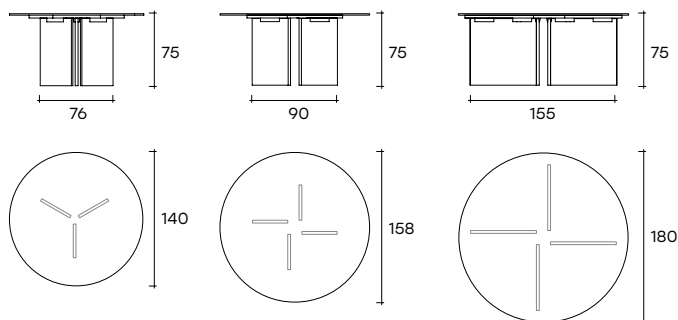

## STRUTTURA DV-GLASS® DV-GLASS® STRUCTURE

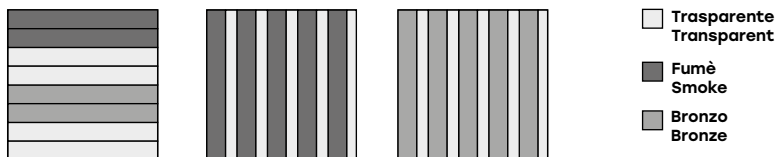

dimensioni Ø, P, H  
dimensions Ø, W, H  
(cm)

	COD./CODE	Ø	P/W	H	peso netto net weight (kg)	peso lordo gross weight (kg)	volume imballo package volume (m³)
Tavolo con piano in vetro trasparente retroverniciato in tinta Cat.1. Base in DV Glass a strisce colorate. Table with top in transparent glass, back-lacquered - color Cat.1. Base made of colored DV glass.	<b>BW-COR140/V-...</b>	Ø140	-	75	99	189	0,68
	<b>BW-COR158/V-...</b>	Ø158	-	75	170	237	0,79
	<b>BW-COR180/V-...</b>	Ø180	-	75	268	368	1,14
Tavolo con piano in vetro ricoperto in Ecomalta finitura Nero Assoluto. Base in DV Glass a strisce fumè e trasparenti. Table with glass top hand-finished with ecomalta, Absolute Black finish. Base in DV-Glass made of smoked and transparent vertical stripes.	<b>BW-FUR140/MNE</b>	Ø140	-	75	100	190	0,68
	<b>BW-FUR158/MNE</b>	Ø158	-	75	170	237	0,79
	<b>BW-FUR180/MNE</b>	Ø180	-	75	270	370	1,14
Tavolo con piano in vetro ricoperto in Ecomalta finitura Tabacco. Base in DV Glass a strisce verticali bronzo e trasparenti. Table with glass top hand-finished with ecomalta, Tobacco finish. Base in DV-Glass made of bronze and transparent vertical stripes.	<b>BW-BRR140/MTA</b>	Ø140	-	75	100	190	0,68
	<b>BW-BRR158/MTA</b>	Ø158	-	75	170	237	0,79
	<b>BW-BRR180/MTA</b>	Ø180	-	75	270	370	1,14

VETRO RETROVERNICIATO _ <i>BACK PAINTED GLASS</i>		
CAT. COLORE COLOR CAT.	COLORI COLORS	CODICE _ CODE
		Vetro trasparente _ <i>Transparent glass</i>
CAT.1 Tinta unita <i>Plain color</i>	Grigio grafite <i>Graphite grey</i>	V-GR
	Testa di moro <i>Dark brown</i>	V-MR
	Nero <i>Black</i>	V-N

DIMENSIONI CUSTOM _ <i>CUSTOM DIMENSIONS</i>			
		DIMENSIONE PIANO _ <i>TOP DIMENSION</i>	
		min.	max.
DIMENSIONE BASE BASE DIMENSION	L 76 cm	Ø 120 cm	Ø 140 cm
	L 90 cm	Ø 145 cm	Ø 175 cm
	L 155 cm	Ø 180 cm	Ø 220 cm

Massima dimensione realizzabile per top laccato ø180.  
*Max feasible dimension for lacquered top ø180.*

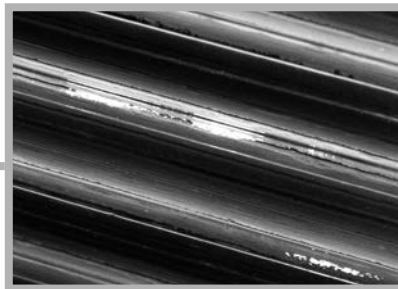

Lievi tracce, avvallamenti superficiali ed irregolarità interne ed esterne alla lastra in vetro sono segni distintivi del processo di fusione ad alta temperatura che ne garantiscono l'artigianalità. Non possono quindi essere oggetto di contestazione.

*Slight traces on the surface, internal and external glass plate's irregularities are distinctive signs of the high-temperature fusion process that guarantee its craftsmanship. They cannot therefore be contested.*

---

**FINITURE**  
**FINISHES**

---

**Base in DV-Glass®**  
**DV-Glass® base**

vetro fuso "Multicolor"  
fused "Multicolor" glass

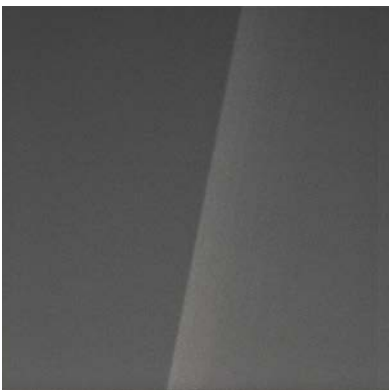
**Piano in vetro verniciato**  
**Back-painted glass top**

grigio grafite  
graphite grey



marrone testa di moro  
dark brown



nero  
black

---

**FINITURE**  
**FINISHES**

---

**Base in DV-Glass®****DV-Glass® base**

vetro fuso bronzo e trasparente  
fused bronze  
and transparent glass



vetro fuso fumè e trasparente  
fused smoked  
and transparent glass

**Piano in vetro spatolato con Ecomalta®****Ecomalta® finish glass top**

tabacco  
tobacco



nero assoluto  
absolute black

**Piano in legno****Wood top**

noce canaletto finitura tabacco  
canaletto walnut, tobacco finish